



Swegon Operations Srl &
SWEGON-ITALY



The background of the slide is a photograph of a woman with long blonde hair in a braid, looking towards a young girl with blonde hair in a bun who is smiling. The scene is set indoors with soft lighting.

Feel good inside

Swegon sviluppa prodotti e sistemi in ambito IEQ da oltre 60 anni.

Focus:

- Efficienza, sostenibilità e comfort
- Ottimizzazione del “life cycle cost”

La nostra promessa ai clienti

Siamo partner per soluzioni tecniche di condizionamento in ambienti indoor, aggiungendo valore dall'inizio alla fine del progetto... e ben oltre.



Perchè l'IEQ è importante

Tempo vissuto in ambienti indoor

87%

I dipendenti soddisfatti del loro ambiente di lavoro sono:

16% *più produttivi*

18% *più predisposti a rimanere*

30% *più attratti dalla loro azienda rispetto ai concorrenti*

Pensiero strategico

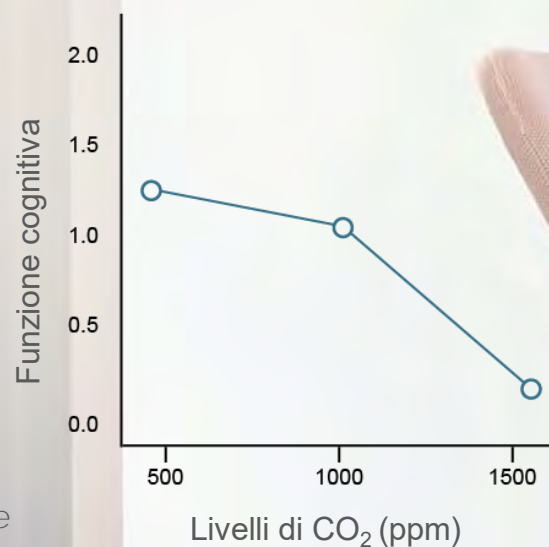

Le persone trascorrono il loro tempo ovunque

Un range completo di applicazioni e prodotti



Unità di
Trattamento
Aria



Room
units



Ottimizzazione
di sistema



Cooling &
heating



Diffusione
aeraulica



Service e
connettività



Ventilazione
Residenziale

Creare l'ambiente ottimale

Approccio di Sistema

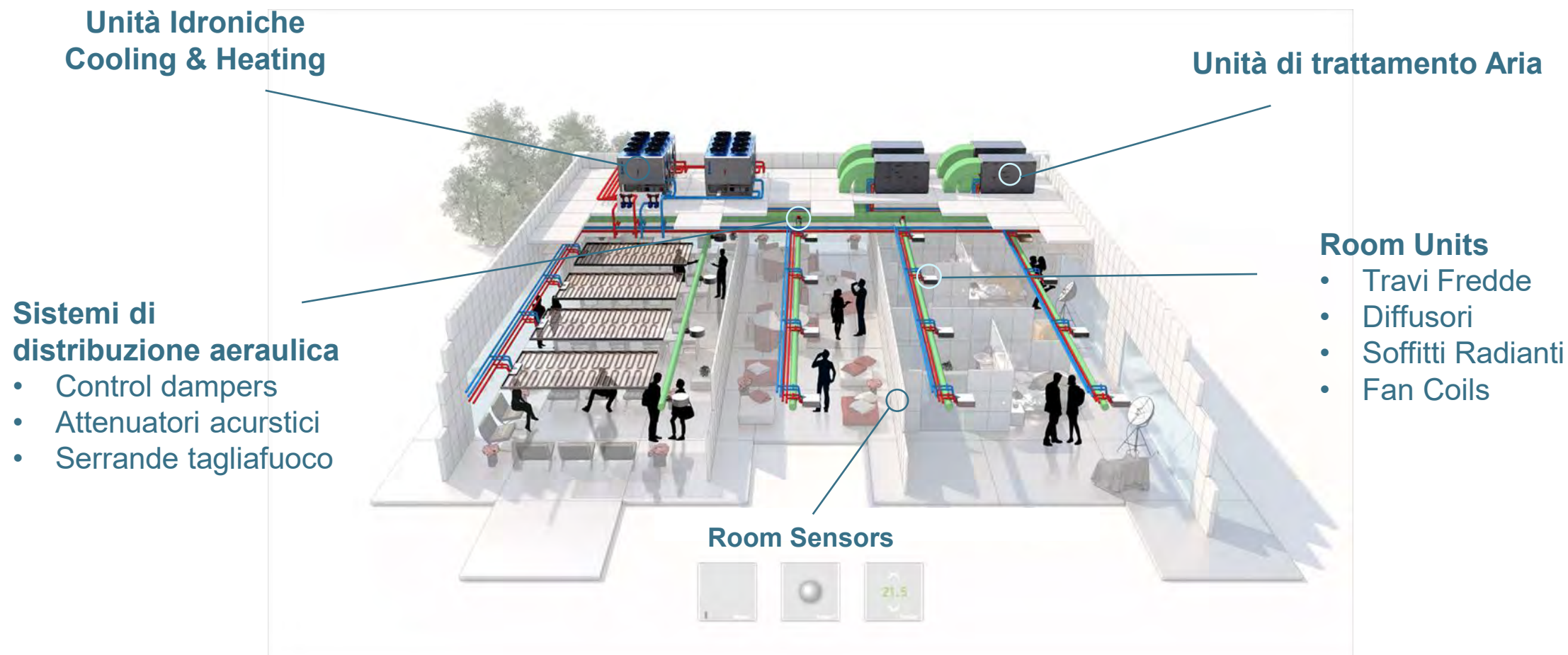

Creare **l'ambiente** ottimale

Una vista a 360° sui controlli di sistema

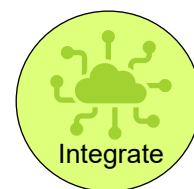
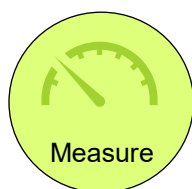
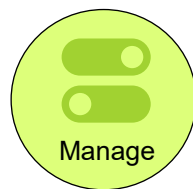
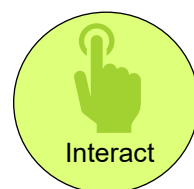
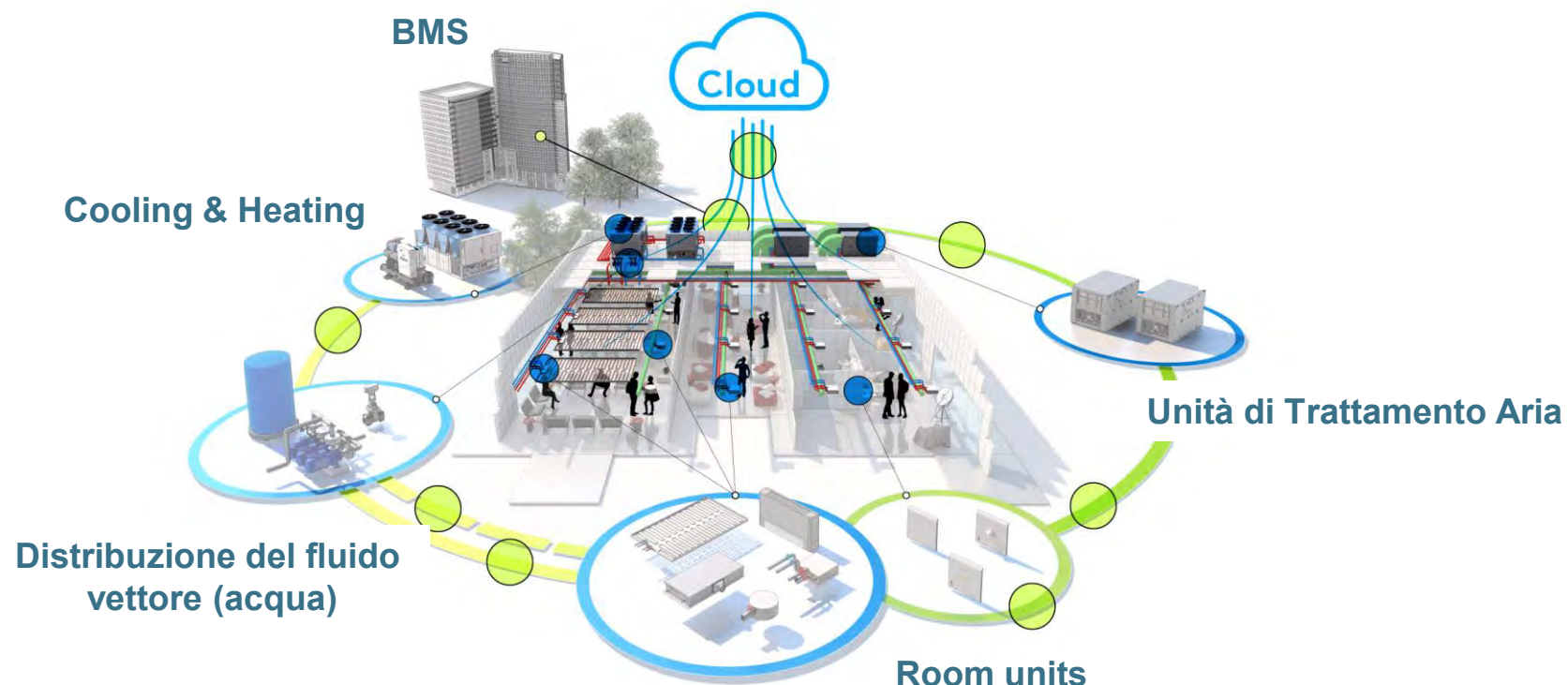

Bellissimi...dentro e fuori

Esempi selezionati da tutto il mondo



Elbphilharmonie



Yale University



Seattle Space Needle



St Marys Axe

Presenza Globale, presidi locali

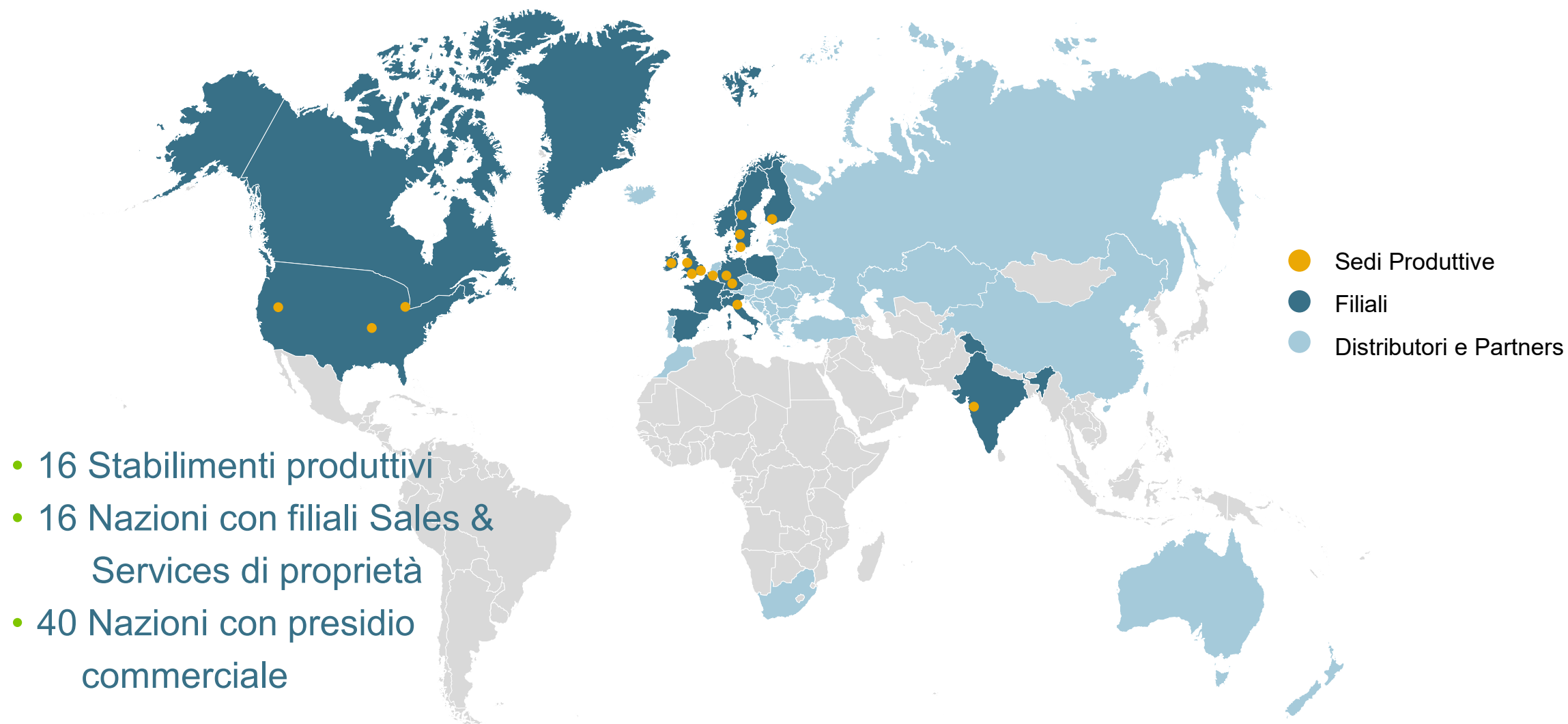

- 16 Stabilimenti produttivi
- 16 Nazioni con filiali Sales & Services di proprietà
- 40 Nazioni con presidio commerciale

La nostra eredità

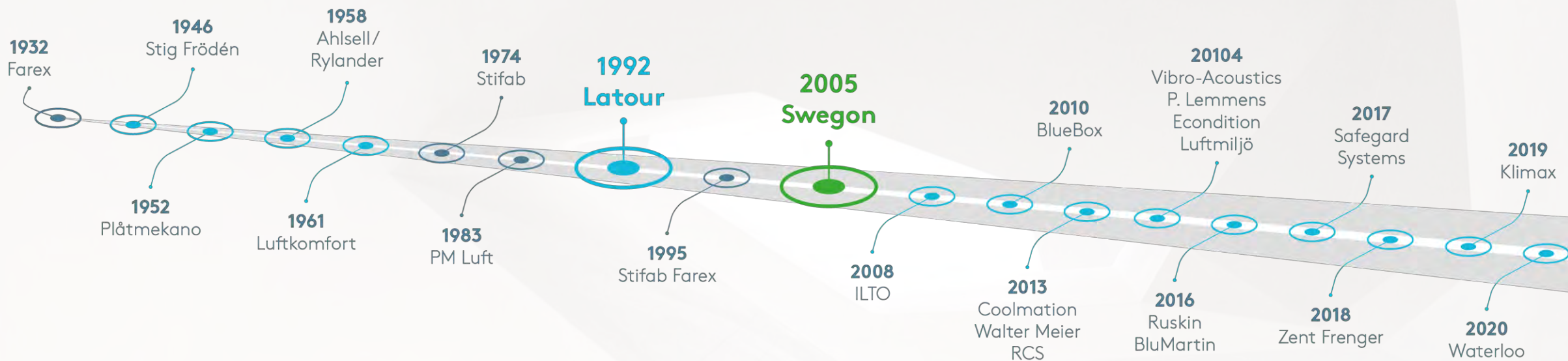

Forti ed affidabili livelli di crescita

2.500

Dipendenti nel mondo

53%

Punteggio NPS 2020 –
Forte Valore del marchio

Alto tasso di crescita, alta redditività

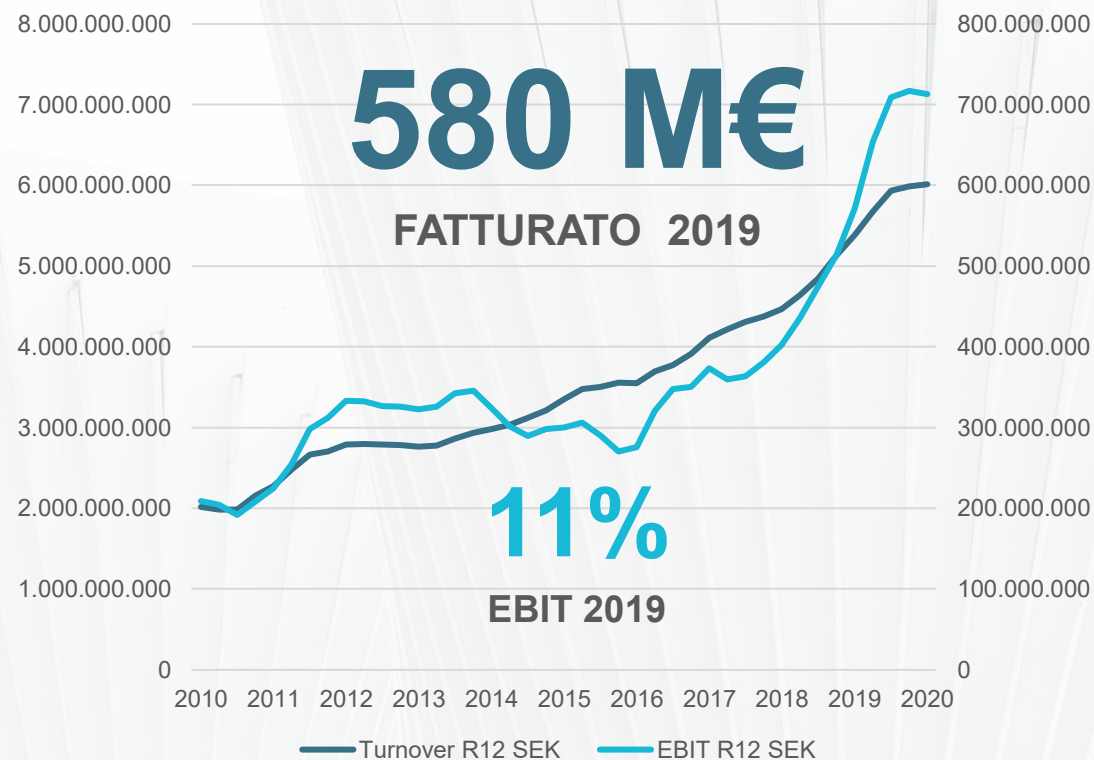

La nostra struttura organizzativa

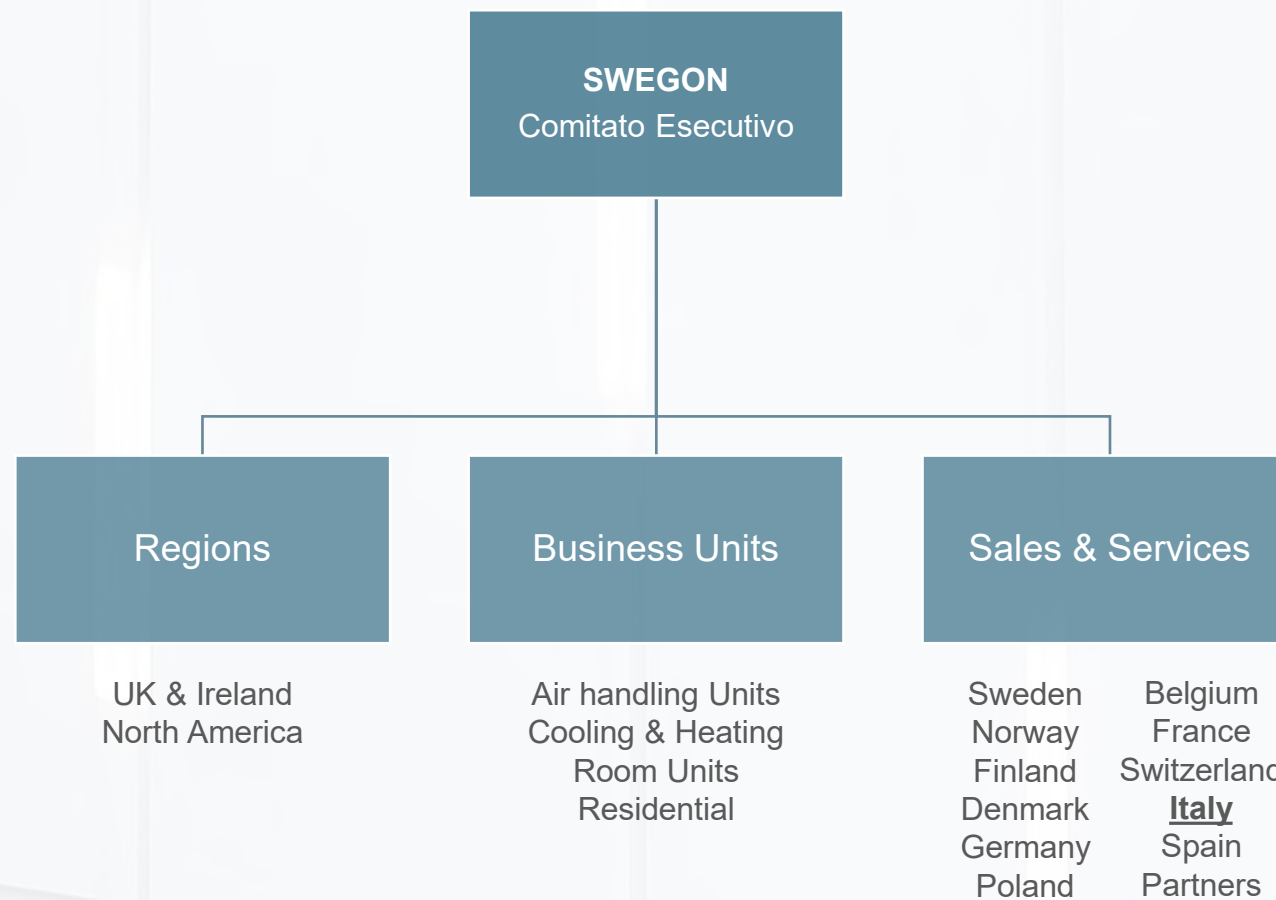

Latour

Long-term owner

- 73% del valore proviene da aziende di proprietà da oltre 20 anni

Holdings

- Notorietà dei Brands, forza dei Prodotti
- Ampia diffusione geografica
- Tecnologie avanzate

Aziende interamente di proprietà

- Fatturato 1,41 Miliardi di Euro (15 billion SEK)
- Più di 5.880 dipendenti nel mondo

Core values

- Prospettiva di Lungo-termine
- Sviluppo

AZIENDE INTERAMENTE DI PROPRIETA'

Caljan

Hultafors Group

Latour Industries

Nord-Lock Group

Swegon

Partly owned holdings

Neuffer

Oxeon

PORTAFOGLIO DI INVESTIMENTI

Alimak Group

ASSA ABLOY

Fagerhult

HMS Networks

Nederman

Securitas

Sweco

TOMRA

Trox

The text "Swegon in Italy" is centered on the page. It is written in a white, sans-serif font. The background behind the text is a series of overlapping, semi-transparent, curved shapes in various colors: orange, yellow, green, teal, and blue. The shapes are layered, with the orange shape on the left and the blue shape on the right, creating a sense of depth and movement.

Swegon Operations S.r.l.

- Location: Cantarana di Cona (VE)
- 24.000 Metri quadrati
- 250 Dipendenti
- produzione, progettazione, R&D



Il nostro impegno

Certificazioni, programmi ed associazioni

Qualità
Affidabilità

Efficienza

Soluzioni
Ecocompatibili



Green
Building
Council
Italia

Test Room

Per collaudare le nostre unità in qualsiasi condizione



- Test Room a controllo entalpico
- Test secondo standard Eurovent
- Standards: UNI EN 14511 / UNI EN 14825
- A2L Ready
- Potenze fino a 1000kW per circuito
- Test della rumorosità secondo EN 3744 / EN 3747 / EN 9614
- Area Test «Close Control Units» per potenze fino a 250kW
- Sala prototipi

Innovation Lab



- Laboratorio a controllo entalpico
- Test secondo standard Eurovent
- UNI EN 14511 / UNI EN 14825
- A2L Ready
- Potenza frigo totale fino a 2.000 kW
- Multiflex double test
- Test della rumorosità EN 3744 / EN 3747 / EN 9614

Product Overview

ZETA REV HEAT PUMP IS NOW
EXTREME

Residencial

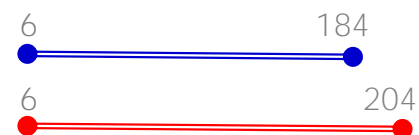

Commercial
& Applies

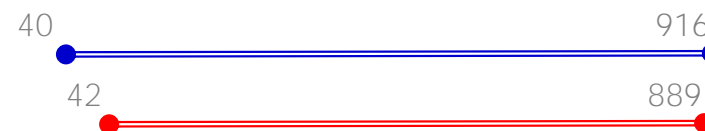

Retail

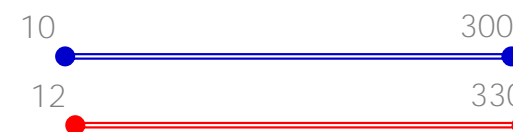

Industrial

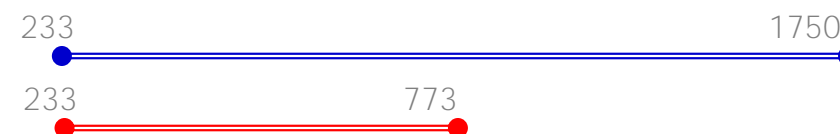

Close Control



Global Warming Potential

Investire nella sostenibilità

Grazie ad una serie completa di Chillers, Pompe di Calore e RoofTops ad alta efficienza energetica, operanti con Gas refrigeranti a BASSO GWP, anche in versione free-cooling.



R7

GWP < 700



R5

GWP < 500

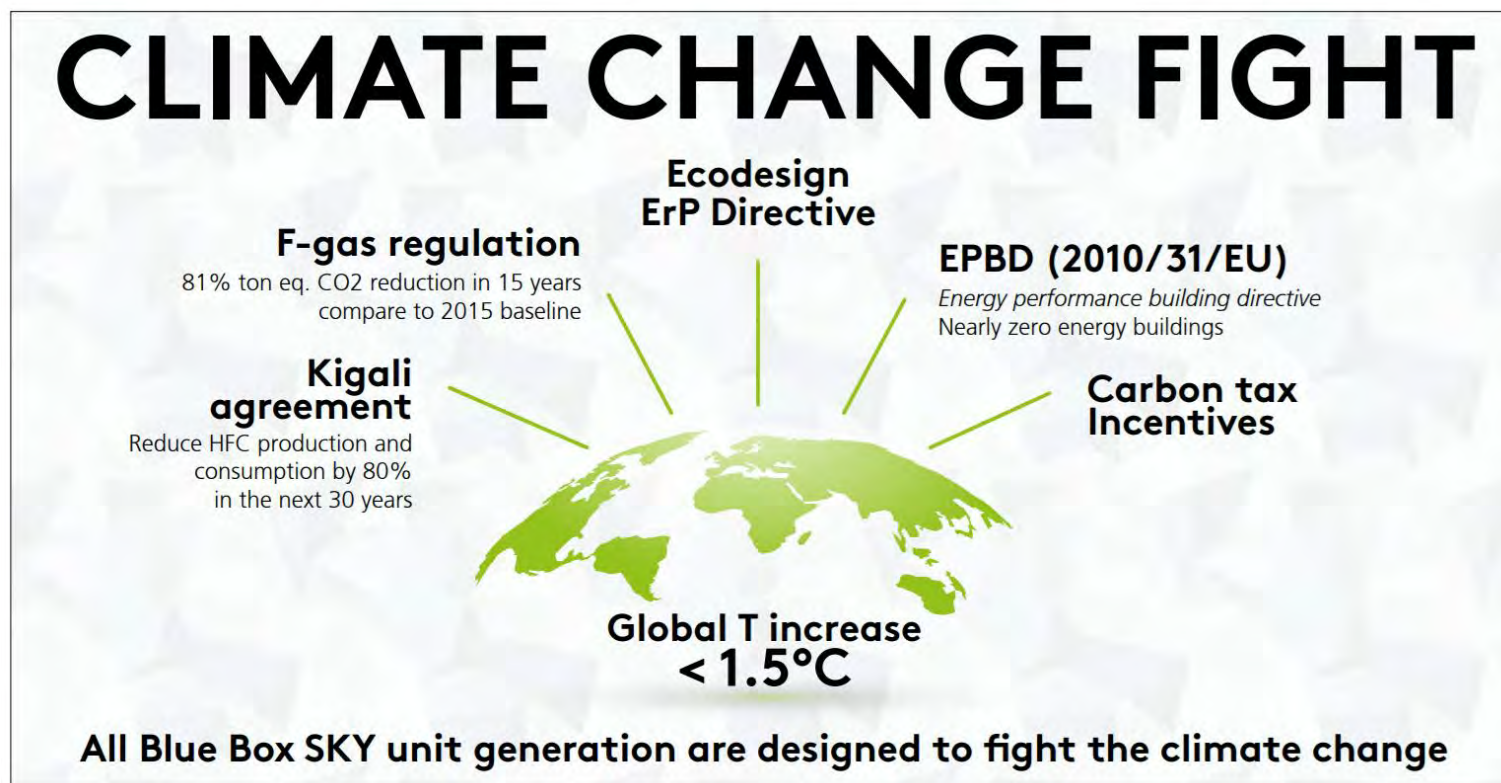

Efficienza di Sistema

HYZER HYDRONIC OPTIMIZER gestione impianto ed ottimizzazione della portata



Circuiti Primario e Secondario a portata d'acqua variabile
 Circuito Portata d'acqua variable all'anello primario

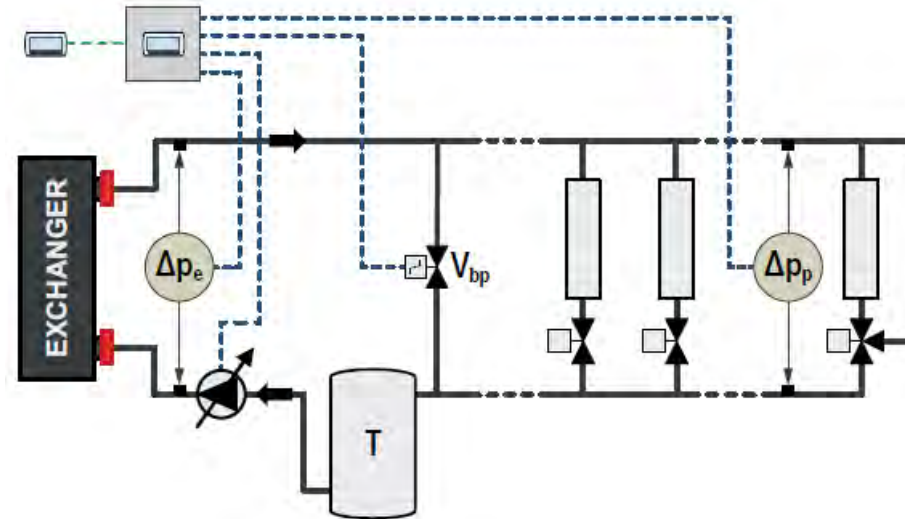
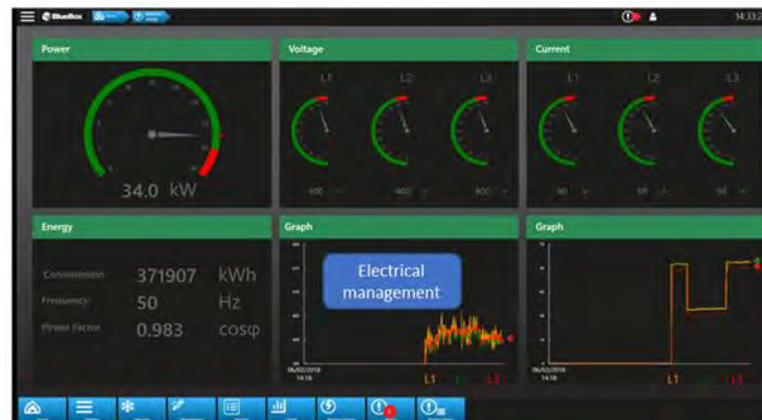

Swegon Italy

Our team

Oltre 200 persone, preparate e motivate:

- *Area tecnica*
- *Area commerciale*
- *Gestione ordini e recupero crediti*
- *Assistenza tecnica post-Vendita*
- *Area ricambi*
- *Gestione contratti di manutenzione*



SWEGON ITALY Team Italia

Swegon Italy

Formazione tecnica e knowledge sharing



Cultura e Tecnica per Energia Uomo e Ambiente

Azienda parte della
Consulta Industriale,
presente nel Consiglio
Direttivo

Smart Training



Swegon Italy

Service & facility

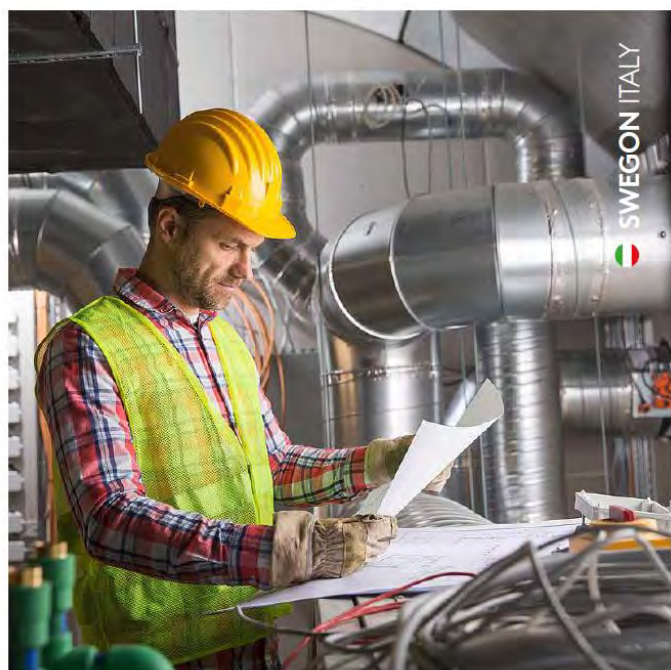

Proteggi il tuo investimento
Servizio di assistenza tecnica specializzata
e Programmi di manutenzione

Swegon Italy, avvalendosi di personale qualificato e specializzato in tutto il territorio Nazionale, offre un ampio ventaglio di servizi di assistenza tecnica che ti aiutano a proteggere il tuo investimento, di prolungare la durata delle tue unità e di minimizzare il rischio di fermo impianto.



- Call Center
- Interventi Tecnici on site
- Assistenza Tecnica telefonica
- Tele-assistenza da remoto
- Estensione Garanzia
- Programmi di Manutenzione ordinaria personalizzati
- Servizio di smontaggio e rimontaggio unità
- Riparazioni e Ricambi
- Consulenze tecniche



Swegon Italy

Partnership



Sponsor Tecnico GRESINI RACING
MOTO GP



Swegon Italy



RIQUALIFICAZIONE GENERALE SHERATON HOTEL MILANO, SAN SIRO

- 35.000 m²
- 7 piani
- 310 camere
- 25 suite



Nr. 3 KAPPA REV XEI SLN 88.2
(inverter)
(Pf, tot = 2.8 MW)

AEROPORTO DI
FIUMICINO - Roma



#2 KAPPA REV LN
(2 MW Cooling Capacity)



ENAV Ciampino - Roma



FLOWZER
Flow Optimizer



#2 POLIVALENTI
OMICRON REV HE
(950 Kw Cooling Capacity)
Flowzer - Multilogic

MASERATI FACTORY - Modena



#1 Gold RX120 + #1 Tetris2A HP 38.4

MASERATI





BANCA D'ITALIA

Installazione: Napoli

Modelli:

ZETA REV HP LN DS 6.2

TETRIS 2A HP LN 28.4

Potenza frigorifera totale: 800kW

NUOVA SEDE DE LONGHI – TREVISO



#10 GOLD RX
#600 Travi Fredde «Pacific»
Sistema DCV - DCIC
Superwise

Oltre 95.000 mq coperti destinati alla produzione, agli uffici e alla logistica.

CASA DI CURA Sant'Anna - Asti

DCV SISTEM – Travi Fredde «Pacific»





INDUSTRIE CELTEX

INDUSTRIE CELTEX - Lucca

#2 Gold ERX
#100 Travi fredde **"Pacific" CAV**
Superwise

ASCOM – Oderzo (TV)



#2 Gold ERX
#80 Travi fredde “Pacific” CAV
Superwise

**CENTRO DIREZIONALE MPS
San Miniato - SIENA
(POLIVALENTI)**



#4 polivalenti OMICRON V EVO HE SLN
(2,4 MW Cooling Capacity)

FERRARI - MARANELLO



#8 OMICRON REV HE S4
(2,3MW Cooling Cap.)
Flowzer VFPP
HYZER

Ca Marcello, Mestre, Italia
16.000 sqm area



AL BAYT STADIUM - QATAR



#32 CRAC UNITS (CW - DX)

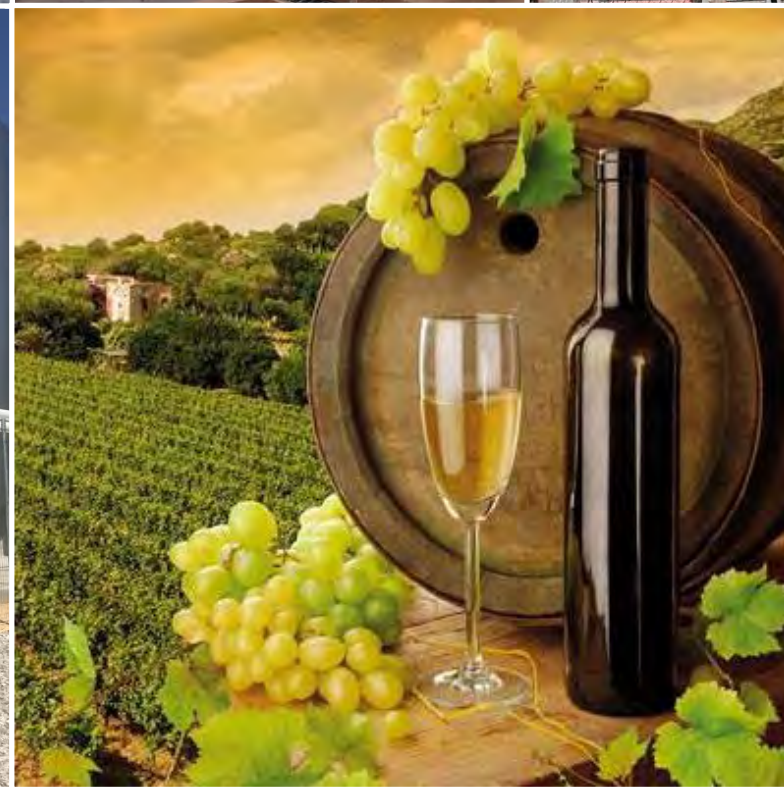

Enología.



ESSELUNGA «Leonardo Da Vinci» - Prato



ROOFTOP UNITS
Lambda Echos HP

INTERSPAR – Concordia Sagittaria (VE)



#5 ROOFTOP UNITS
Lambda Echos HP

BRICOMAN
Sesto Fiorentino – Firenze



#3 ROOFTOP UNITS
Lambda Echos HP FC3S

IPER TOSANO- Verona



#2 TETRIS2 37.4 (720kW Cooling Cap.)

#3 LAMBDA ECHOS 16.2 (320kW Cooling Cap.)

PITTARELLO SHOES - Roma



#2 ROOFTOP UNITS
Lambda Echos HP RS4S SLN



Feel good **inside**

SWEGON-ITALY